

120W constant Voltage-LS Series



■ Approve



Features

- Class II, SELV, independent
- Input Voltage 220-240VAC
- Protections: SCP/OLP/OVP/OTP
- Power Factor > 0.9
- Efficiency ≥91%
- 5 years warranty

Applications

- LED strips

◆ Description

LS-120-XX LI1 is a 120W constant voltage LED driver that operates from 198-264Vac input with 24V or 48V output voltage. With its compact dimensions from 268 x 45 x 30.5mm it is easy to integrate in LED strips products. To ensure trouble-free operation, protection is provided against output short circuit and over Load.

◆ Model code

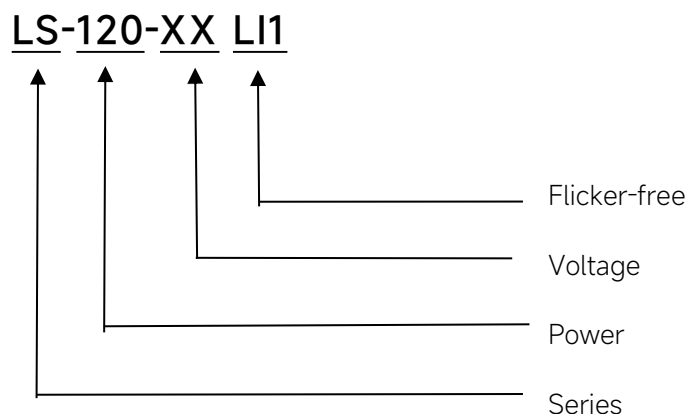

◆ Specification

Output	Constant Voltage	24±1VDC	48±1VDC
	Current Range	5A Max.	2.5A Max.
	Voltage Accuracy	±5%	
	Output HF current ripple(≥1KHz)	±5%	
	Output LF current ripple(≤120Hz)	±5%	
	SVM	≤0.4@Full Load	
	Pst	≤1@Full Load	
	Efficiency(Typ.)	91%	
Input	Rated input voltage	220-240VAC	
	Range of input voltage	198-264VAC	
	Frequency(Hz)	0/50/60 Hz	
	Power Factor	> 0.9	
	Input Current max	0.74A	
	Start-up time	< 0.5S	
	No Load Power	≤0.5W	
	THD (Typ.)	< 10%	
Protection	Over Load Protection	105-150%	
		YES/Auto Resume	
	Over Voltage Protection	> 25.2Vdc	> 50.4Vdc
		YES/Auto Resume	
	Short circuit Protection	YES/Auto Resume	
	Over Temperature Protection	YES/Auto Resume	
Environment	Operating Temperature	-20°C~+45°C	
	Humidity	20%-90%RH	
	Tc	85°C	
	Storage Temperature	-20°C~+60°C	
	Life time	> 50000h@Tc=80°C	
Surface	Dimension	268X45X30.5(LXWXH)mm	
standards	EN 61347-1; EN61347-2-13; EN62384; EN55015; EN61000-3-2 ; EN61000-3-3; EN 61547;		
Others	ErP	EU 2019/2020	
	RoHS	RoHS (2011/65/EU) (EU)2015/863	
Note	1.All parameters NOT specially mentioned are measured at 240VAC input , full load and 25°C of ambient temperature. 2.Ripple & Noise are measured at 20MHz of bandwidth by using a 300mm twisted pair-wire terminated with a 0.1uF & 47 uF parallel capacitor.		

◆ Wiring diagram

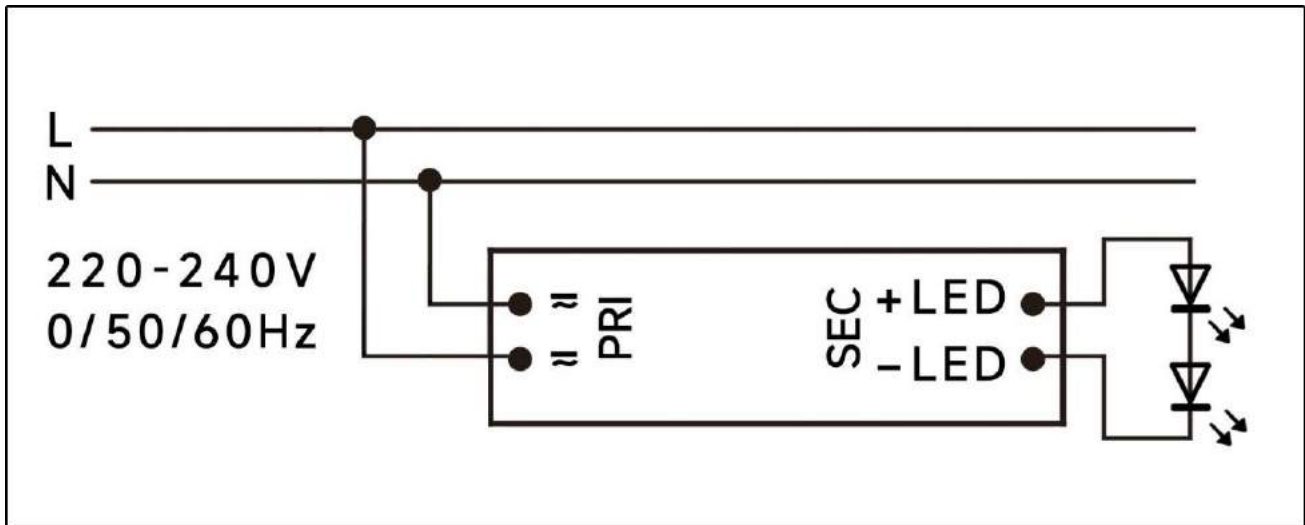

◆ 2D diagram

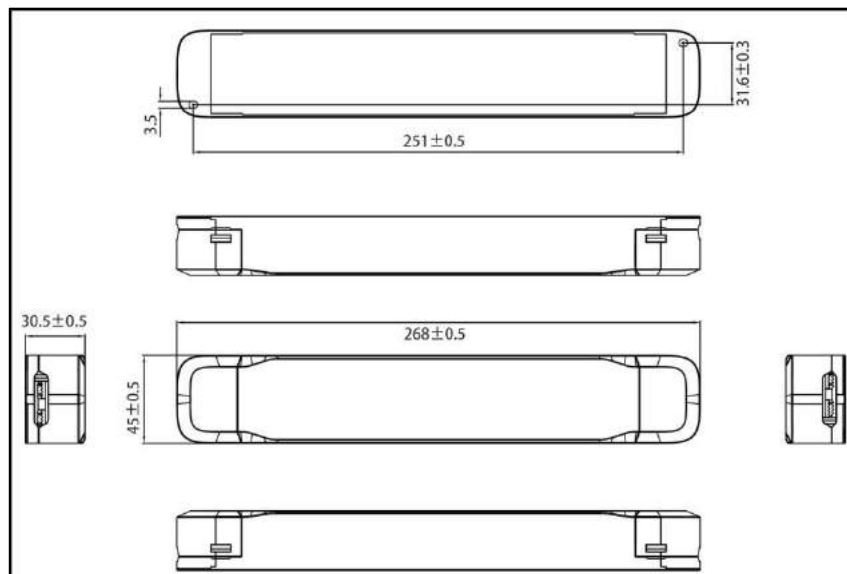

◆ Wiring & Connections

Specification item		Value (Unit)
Input	Input wire cross-section	0.5...1.5 mm ²
	Input wire gauge.	16...20 AWG
	Input wire strip length	7...9mm
Output	Output wire cross-section	0.5...1.5 mm ²
	Output wire gauge.	16...20 AWG
	Output wire strip length	7...9mm

◆ Curve for LS-120-48 LI1

Lifetime vs. Temperature Curve

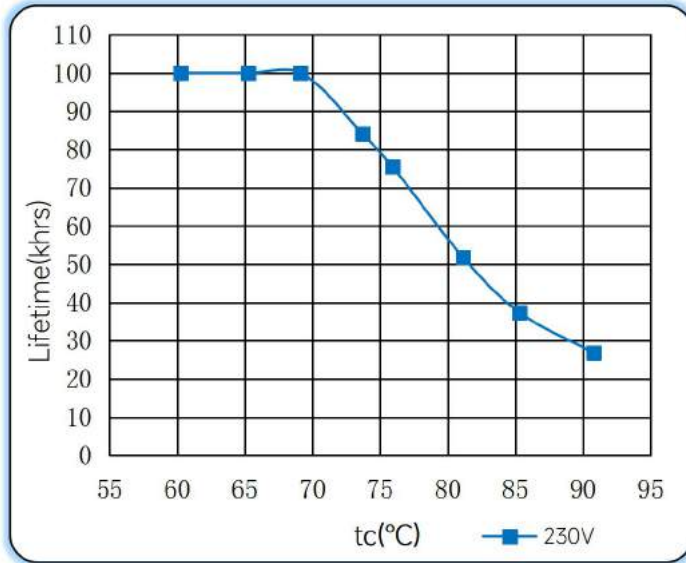

Efficiency vs. Load

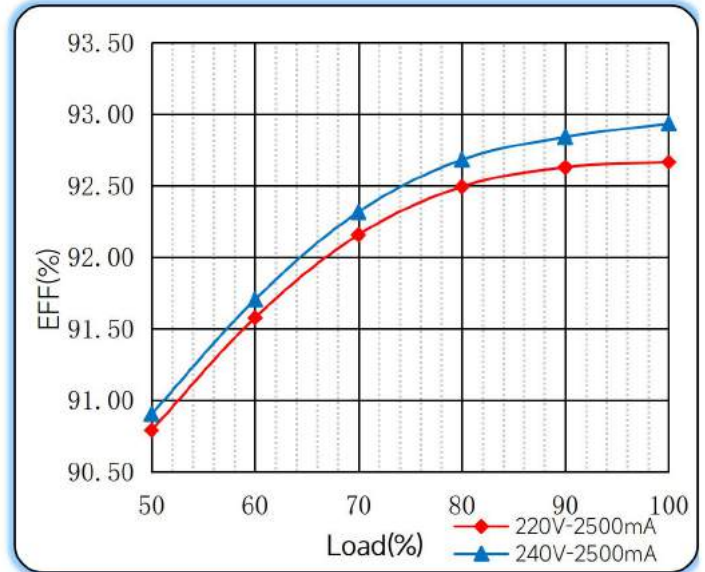

Power Factor Characteristics

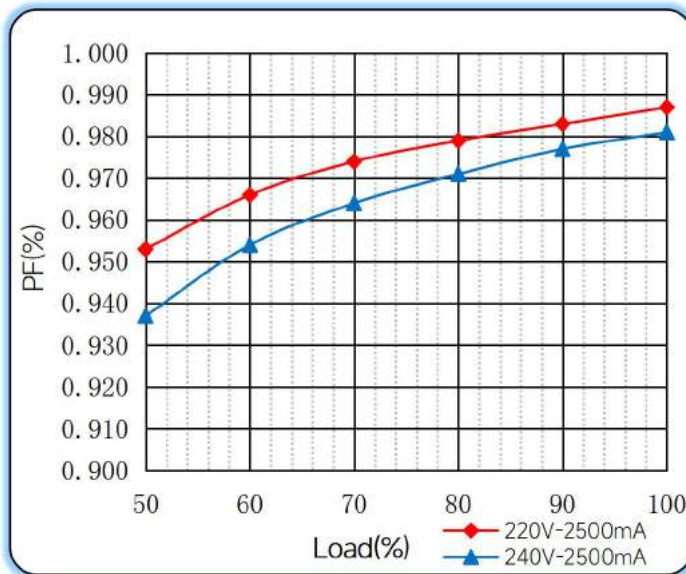

THD vs. Load

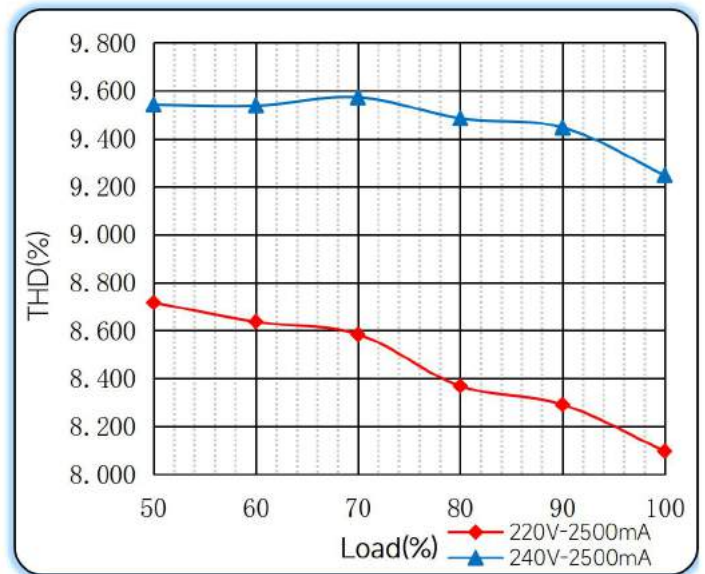

◆ Operating window

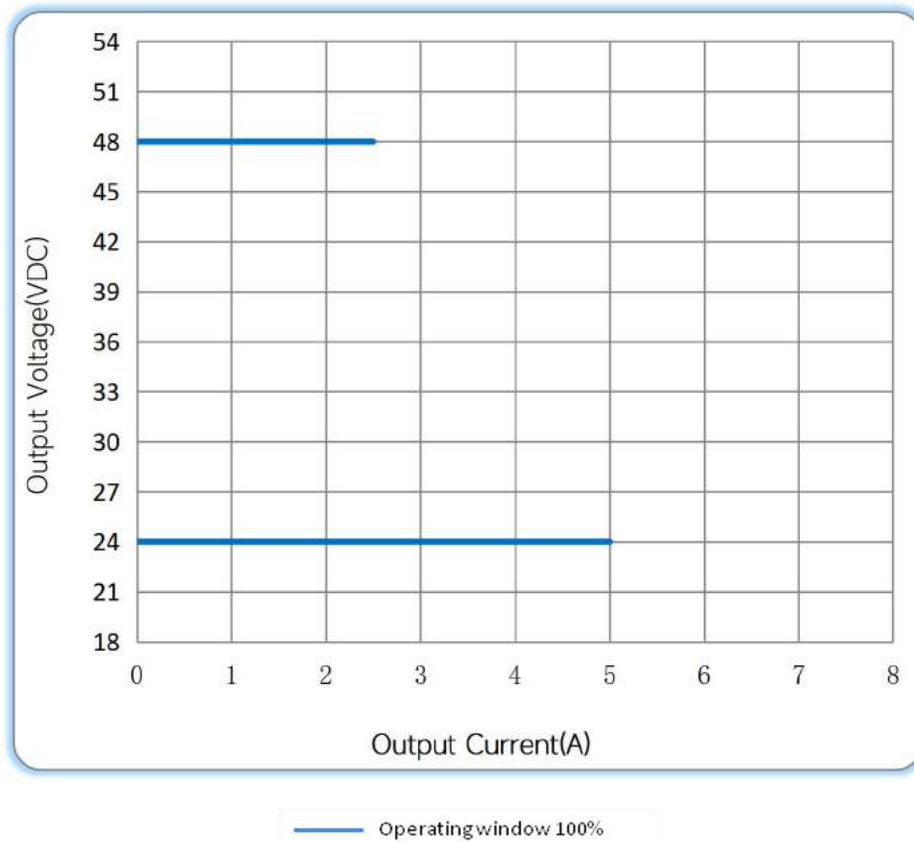

◆ Revision Updates

ITEM	BEFORE	AFTER	VERSION	DATE
Initial			A	2022/05/15

Tel: +86-0757-86256822, +86-0757-86256831

E-mail: sales@eaglerise.com

Website : <https://lighting.eaglerise.com>



EAGLERISE



Manual